

10%
made in Italy

Medical Line

DreaMed

Universal medicine
Medicina universale



Multifunctional couch-bed
Poltrona-lettino multispecialistica

Lemi[®]
MADE IN ITALY

Movements / Movimentazioni

ENT VISITS • DENTAL SURGERY AND IMPLANTOLOGY
STOMATOLOGY • ORTHODONTICS • OPHTHALMOLOGY
DIAGNOSTICS • MINOR SURGERY INTERVENTIONS

4 independent electric movements: height, back rest, leg rest, trendelenburg
1 synchronized electric movement: back rest/leg rest
2 manual movements: rotation and leg rest extension
Automatic reset control to bring the couch back to the initial position

Electric height
Altezza elettrica
52-82 cm
(20"-30")



Electric Trendelenburg
Trendelenburg elettrico



30°



180°

90° rotation on both sides
Rotazione 90° da entrambi i lati

VISITE DI OTORINOLARINGOIATRIA • CHIRURGIA DENTALE E IMPLANTOLOGIA
STOMATOLOGIA • ORTODONZIA • OFTALMOLOGIA
DIAGNOSTICA • PICCOLI INTERVENTI AMBULATORIALI

DreaMed • cod. 333

4 movimenti elettrici indipendenti: altezza, schiena, gambe, trendelenburg
1 movimento elettrico sincronizzato: schiena/gambe
2 movimenti manuali: rotazione ed estensione gambe
Comando di azzeramento automatico che riporta il letto nella posizione base

Synchronized back rest/leg
rest movement

Movimentazione sincronizzata
schiena/gambe

Electric leg rest
Gambe elettriche



Electric back rest
Schiena elettrica



3 motors version cod. 330

3 manual movements:
rotation, leg rest inclination and extension

Versione 3 motori cod. 330

3 movimenti manuali:
rotazione, inclinazione ed estensione gambe

ENT VISITS • DENTAL SURGERY AND IMPLANTOLOGY
STOMATOLOGY • ORTHODONTICS • OPHTHALMOLOGY
DIAGNOSTICS • MINOR SURGERY INTERVENTIONS



Easy-to-clean anatomic
mattress without stitching

*Materasso anatomico
senza cuciture per una
facile igienizzazione*

Its complete ABS covering
grants elegance and safety
while protecting the inner
components from liquids

*Completamente chiuso con
carter in ABS garantisce
alla poltrona eleganza e
sicurezza, proteggendo i
componenti interni dai liquidi*

2 adjustable small feet
under the base

*2 piedini regolabili
alla base*

Wide choice of upholsteries
available on stock

*Ampia scelta di rivestimenti
disponibili a stock*

Maximum load weight
without risk 200 kg

*Portata max in sicurezza
200 kg*

Predisposition for medical
accessories to adapt the
couch to any purpose

*Predisposizione accessori
medicali per adattare la
poltrona ad ogni utilizzo*

4 electric actuators current
continuous 24V cc

*4 motori elettrici 24V cc
a regolazione continua*

Foot pedal control with
automatic reset to zero

*Pedaliera con azzeramento
automatico*



Technical specifications

Minimum height: 52 cm - 20"
Maximum height: 82 cm - 32"
Angle of inclination trendelenburg: 30°
Angle of inclination back rest: 80°
Angle of inclination leg rest: 90°
Mattress length: 168 cm - 66"
Mattress length (with extended leg rest):
185 cm - 73"
Mattress width: 59 cm - 23"
Rotation: 90° on both sides
Latex-free, non-toxic and non-carcinogenic
materials
Fire-resistant upholstery: UNI 9175 class 1M

Specifiche tecniche

Altezza minima: 52 cm
Altezza massima: 82 cm
Angolo inclinazione trendelenburg: 30°
Angolo inclinazione schiena: 80°
Angolo inclinazione gambe: 90°
Lunghezza materasso: 168 cm
Lunghezza materasso gambe estese:
185 cm
Larghezza materasso: 59 cm
Rotazione: 90° su entrambe i lati
Materiali privi di lattice, atossici e non
cancerogeni
Rivestimento ignifugo: UNI 9175 class 1M

Electric requirements

Voltage: 230V ac, 110V ac
Frequency: 50 Hz / 60 Hz
Absorption: 0,70 A max
Electric system conforms to CEI norms
4 actuators 24V cc (thrust 6000 N)
Class II control box 220Vac 50Hz
Transformer 120 Va
Class I medical device (dir. 93/42/CEE)
Protection rating IP54
Low-tension foot pedal control

Packaging details

Size: 170x74x86h cm (67"x30"x34")
Volume: 1,081 m³
Gross weight: 92 kg - 203 lbs
Net weight: 76 kg - 168 lbs

Caratteristiche imballo

Dimensioni: 170x74x86h cm
Volume: 1,081 m³
Peso lordo: 92 kg
Peso netto: 76 kg

Caratteristiche elettriche

Voltaggio: 230V ac, 110V ac
Frequenza: 50 Hz
Assorbimento: 0,70 A max
Impianto elettrico a norme CEI
4 attuatori 24V cc (spinta 6000N)
Centralina in classe II 220 Vac 50Hz
Trasformatore da 120 Va
Disp. Medico classe I (dir. 93/42/CEE)
Grado di protezione IP54
Pedaliera a bassa tensione

Warranty

Structure: 10 years
Motors and control: 2 years
Cushion: 5 years

Garanzia

Struttura: 10 anni
Motori e comandi: 2 anni
Imbottitura: 5 anni

Accessories upon request / Accessori su richiesta

The standard version includes flat armrests
La versione standard include i braccioli automatici



cod. 108



cod. 316-317



cod. LEM-084



cod. GOP-012



cod. 331



cod. 314



cod. 318



cod. 313



cod. LEM-139



cod. 319-320



cod. LEM-151

cod. 108roll holder/*porta rotolo***cod. 316-317**seat and back rest medical guide couple
*coppia guide medicali seduta e schiena***cod. LEM-084**hand set control / *pulsantiera***cod. GOP-012**lamp adaptor featuring a 60 mm
diameter column
*adattatore per supporto lampada
completo di colonna ø60 mm***cod. 331**metal tray with support/*vassoio con supporto***cod. 314**blood-sample taking armrest
*coppia braccioli da prelievo con snodo***cod. 318**jointed thigh support couple
*coppia reggicoste con snodo***cod. 313**medical armrest couple
*coppia braccioli medicali***cod. LEM-139**wheels/*ruote***cod. 319-320**fixed and rotating clamp couple
*coppia morsetti fissi girevoli***cod. LEM-151**heel support couple/*coppia reggi tallone***Mattress colors / Colori materasso****P35**

Bianco

**B41**

Grigio

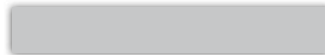
**B99**

Nero

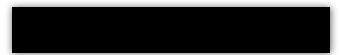
**D02**

Crema

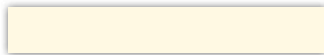
**G10**

Blu

**H98**

Viola

**G03**

Azzurro

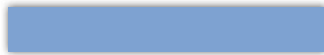
**EB1**

Verde

**E16**

Marrone

**G85**

Cielo

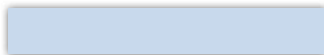
**N31**

Arancio

**Q73**

Mais

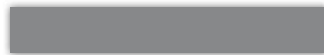
**ABS covering colors/ Colori carter****333 G**Light grey
Grigio**333 B**White
Bianco

The colors above are provided only as a guide and could be subjected to a variation due to the material different from the printed paper.

I colori sopra riportati sono indicativi e possono essere soggetti a variazioni dovute al materiale diverso dalla carta stampata.

Product images are for illustrative purposes only.
The manufacturer has the right to modify pictures and descriptions
of this catalogue at any time for commercial or technical purposes.

*L'immagine ha il solo scopo illustrativo.
Il costruttore si riserva il diritto di effettuare le modifiche
alle immagini e alle descrizioni di questo catalogo
in ogni momento per esigenze di carattere
tecnico e commerciale.*

credits:

photo by Studio Pi-Tre



N° 443.090.V



Table of dimensions / *Tabella dimensionale*

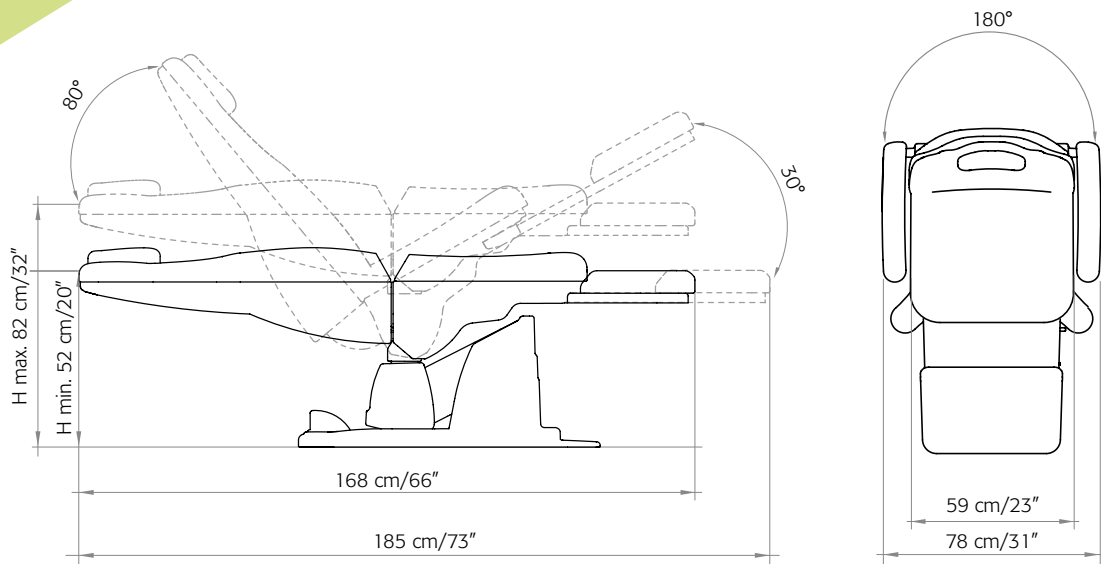

DreaMed is CE conformed and is manufactured in accordance with
European Directives: 93/42/CE (class I); 2006/42/CE; 2004/108/CE;
CEI EN 60204-1:2006-09; UNI EN 12100-1-2

*DreaMed è a norme CE ed è fabbricato in conformità alle seguenti Direttive
Europee: 93/42/CE (classe I); 2006/42/CE; 2004/108/CE;
CEI EN 60204-1:2006-09; UNI EN 12100-1-2*



Lemi[®]
MADE IN ITALY